

# BELLA FIGURA

## Athena Lamp

TL823

Collection Name  
**VEGA COLLECTION**

An ode to the deity, Athena, a goddess of wisdom and craft. This contemporary model is styled on the traditional form of a Greek amphora with exaggerated, angular arms in stark contrast to its rounded body. Athena is an adaptable statement piece which possesses the ability to claim focus or quietly set the tone of its setting depending upon the selection of finishes.

### Compatible with



Yacht Club



TL823 in Dapple Grey and Polished Brass with 12" Tall Drum Shade in Bennett's Dupion Silk Nightingale 5018W/116

### Available Finishes

#### Ceramic Finish

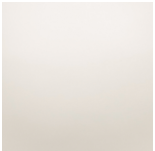

Chalk



Crackle



Jasper

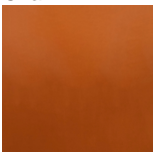

Tabasco

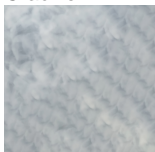

Dapple Grey

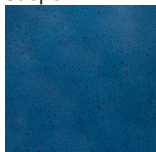

Starry Sky

#### Neck and Bulb Holder

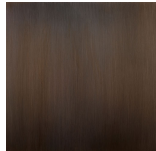

Bronze

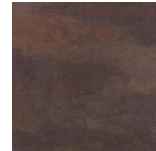

Old English  
Brass

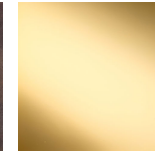

Polished Brass



Polished Nickel

#### Recommended Shade(s) (OPTIONAL)

12" Tall Drum

#### Silk Flex

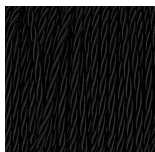

Black



Cream

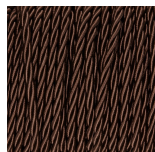

Brown



Silver

**Available Sizes**

---

**Size One**

TL823,

Height: 46.3 cm (18.23")

Diameter: 20.5 cm (8.07")

Bulbs: 1 x 40W E27

Cable Exit: Bottom

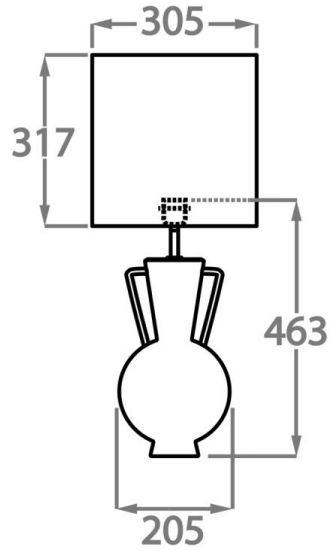

Dimensions are measured from the base of the lamp to the middle of the bulb holder and are excluding shade.  
Overall height with recommended 12" tall drum shade is 74.2cm - 29.2"