

BELLA FIGURA

Athena Lamp

TL823

Collection Name
VEGA COLLECTION

An ode to the deity, Athena, a goddess of wisdom and craft. This contemporary model is styled on the traditional form of a Greek amphora with exaggerated, angular arms in stark contrast to its rounded body. Athena is an adaptable statement piece which possesses the ability to claim focus or quietly set the tone of its setting depending upon the selection of finishes.

Compatible with



Yacht Club



TL823 in Chalk and Bronze with 12" Tall Drum Shade in Bennett's Dupion Silk Nightingale 5018W/116

Available Finishes

Ceramic Finish

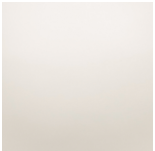

Chalk



Crackle



Jasper

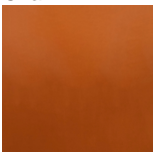

Tabasco

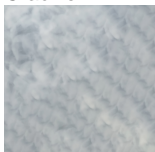

Dapple Grey

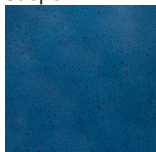

Starry Sky

Neck and Bulb Holder

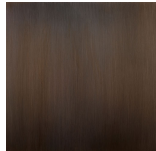

Bronze

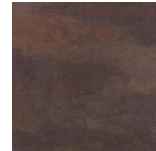

Old English Brass

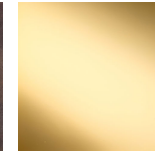

Polished Brass



Polished Nickel

Recommended Shade(s) (OPTIONAL)

12" Tall Drum

Silk Flex

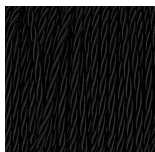

Black



Cream

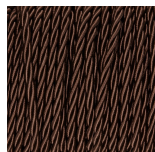

Brown



Silver

Available Sizes

Size One

TL823,

Height: 46.3 cm (18.23")

Diameter: 20.5 cm (8.07")

Bulbs: 1 x 40W E27

Cable Exit: Bottom

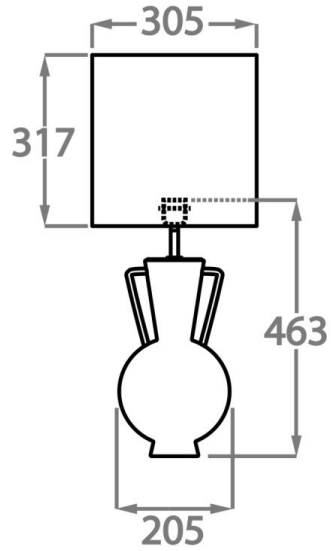

Dimensions are measured from the base of the lamp to the middle of the bulb holder and are excluding shade.
Overall height with recommended 12" tall drum shade is 74.2cm - 29.2"